

de Montageanleitung

en

Assembly Instructions

nl

Montagehandleiding

fr

Instructions de
montage

es

Instrucciones de
montaje

559112

Wasserstraßensystem maxi

RM-code:

0204-V-03-dm

Achtung:

Unterlagen unbedingt aufbewahren!
Bei allen Fragen und Reklamationen bitte RM-code angeben.

Montagehinweis:

Flachrundschraben bitte nur mit dem Gummihammer nachklopfen, da sonst der Korrosionsschutz zerstört wird. Bitte bei allen Muttern eine entsprechende Scheibe unterlegen und alle Muttern mit 'Gefühl' festziehen. Wird die Mutter überdreht, so reißen vor allem unter dem Schraubenkopf unnötig viele Holzfasern auf. Alle Senkungen sind zum Versenken der Schraubenmutter vorgesehen. Das Aufsetzen der Muttern in den Senkungen wird erleichtert, wenn man eine oder zwei Muttern in die Nuss einlegt und damit auf die Schraube aufsetzt. Für die Montage des Gerätes wird eine zugkräftige Zweigangbohrmaschine benötigt.

Anforderungen an das Geländeprofil:

Bitte orientieren Sie sich an den Angaben in unseren Ausschreibungsunterlagen und dem Fundamentplan. Bitte vergewissern Sie sich vor Inbetriebnahme, dass alle Montagehilfsmittel entfernt sind. Wenn am Aufstellungsort außergewöhnliche Bedingungen festzustellen sind wie z.B. Torfboden oder gefrorener Boden, dann müssen diese Bedingungen bei der Fundamentdimensionierung beachtet werden.

Die Aufbauhinweise in der Wartungsanweisung sind zu beachten.

Weitere Informationen finden Sie ebenfalls in der beiliegenden Wartungsanleitung!

Weiter sind ggf. in den nachfolgenden Seiten dieser Dokumentation Sachverhalte z.B. bei Aufbauanleitungsschritten und Detailblättern angegeben, die ebenfalls bei der jährlichen Hauptinspektion zu berücksichtigen sind.

Fußnoten:



Aufprallfläche nach EN1176

a) Die gelbe (innere) Fläche zeigt die Aufprallfläche mit Anforderungen an die Stoßdämpfung.

Bodenbeschaffenheit innerhalb der Aufprallfläche (DE/AT/NL):							
✓	✓	✓	✓	✓	✓	✓	✓
Sand	Kies	Holzschnitzel	Synthetischer Fallschutz	Rasen	Oberboden	Beton	Stein
Bodenbeschaffenheit innerhalb der Aufprallfläche (sonstige Länder):							
✓	✓	✓	✓	✓	✓	✓	✓
Sand	Kies	Holzschnitzel	Synthetischer Fallschutz	Rasen	Oberboden	Beton	Stein

b) Die äußere Linie umschließt die gesamte Aufprallfläche.

Generell muss um jedes Spielgerät ein Abstand von 1,5m bemessen werden, der frei von harten und scharfkantigen sowie vorstehenden Teilen ist.

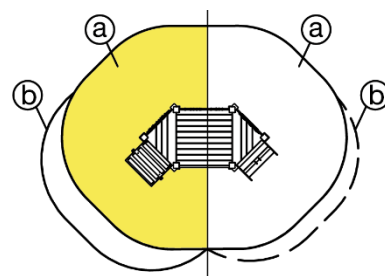

























































Legende Fundamentliste

- ID = Fundamentnummer
- Type = OF=Ortbetonfundament C20/25,
= FFk=eibe-Fertigfundament,
= FFr=eibe-Fertigfundament rund,
= FFg=eibe-Fertigfundament groß,
= FL3=NACH Montage erstellen!
- X = horizontales Maß zum 0-Punkt
- Y = vertikales Maß zum 0-Punkt
- Z = Lochtiefe zum Oberboden
- α = Drehung Fundament
- FS = Größe Fundament: Länge x Breite x Höhe (L x W x H)
- DS = Größe Drainageschicht: Länge x Breite x Höhe (L x W x H)
- SP = Rutschenanbaupunkt (Slide Point)



Rutschen sind nicht im Lieferumfang enthalten.

Sichere Benutzung nur mit eibe Rutsche oder Schließen der Öffnung entsprechend EN 1176.
Detaillierte Angaben wie z.B. Aufprallfläche oder Fundamente entnehmen Sie bitte der separat beiliegenden Rutschen-Montageanleitung.

 Gerätedaten	 Norm	 Anzahl Benutzer
 Altersklasse	 Mindestraum	 Maximale freie Fallhöhe
 Wartungsintervall in Monate	 Wartung	 Übersichtsplan
 Pfostenübersicht	 Fundamentplan	 eibe-Fertigfundament
 Ortbetonfundament	 Fundamentliste	 Detailblatt / Aufbaubeispiel
 Aufprallflächenplan	 Ortbetonfundament mit Betonsorte C20/25	 Lieferumfang
 Nicht im Lieferumfang enthalten	 Verschleißteil (Nicht in der Gewährleistung mit inbegriffen)	 Wartezeit in Tagen
 Aufbauschnitt	 Ansicht um 90° gedreht	 Ansicht um 180° gedreht
 Beipack	 Anzeichnen	 Maße angeben in m
 Maße angegeben in cm	 Messen	 Ausrichten
 Bohren (ø = Bohrdurchmesser)	 Bohren (t = Bohrungstiefe, ø = Bohrdurchmesser)	 Mit Hammer befestigen
 Schrauben festziehen	 Senkbohrungen mit Verschlussstopfen verschließen	 Abschneiden
 Abstand	 Achtung	 Nach Montage entsorgen
 Kein Durchhang	 Keine Überschneidung	 Schraubensicherung
 Korrekt	 Falsch	 Konzipiert für den betreuten Bereich
 Konzipiert für den Innenbereich	 Darf nur unter Aufsicht benutzt werden!	 Checkliste
 größtes Teil	 schwerstes Teil	 Anzahl Fundamente
 Fundamentlevel	 Aufprallfläche mit Anforderungen	 Aufprallfläche ohne Anforderungen
 Drainage	 Aushub	

Attention:

Please keep these documents!
Please indicate the RM-code on all inquiries and complaints.

Installation notes:

Knock round-head screws only with a rubber hammer to avoid damaging the anticorrosive coating. Use washers underneath all nuts and tighten them carefully. If overtightened, an unnecessary number of wood fibres under the screw head will tear. Counterbores are provided for countersinking the screw nuts. For easier positioning in the counterbores, insert one or two screw nuts into the nut and place on the screw. Use a high-performance two-speed power drill for the assembly of the play equipment.

Site requirements:

Please refer to the information in our tender documents and in the foundation plan. Before putting the equipment into service, ensure that all assembly tools have been removed. Unusual site conditions such as peat soil or frozen underground must be taken into account for the dimensioning of the foundation.

The assembly instructions in the maintenance manual must be observed.

Further information can also be found in the enclosed maintenance instructions!

Further particular information and installation details, which are eventually to be considered for the yearly inspection, are specified in this documentation.

Fußnoten:



Impact surface in accordance with EN1176

a) Yellow (inner) area shows the impact surface with shock absorption requirements.

Surfacing inside the impact area (DE/AT/NL):							
✓	✓	✓	✓	✓	✓	✓	✓
Sand	Gravel	Wood chips	Impact-attenuating tiles	turf	Top soil	concrete	stone
Surfacing inside the impact area (other countries):							
✓	✓	✓	✓	✓	✓	✓	✓
Sand	Gravel	Wood chips	Impact-attenuating tiles	turf	Top soil	concrete	stone

b) The outer line encloses the entire impact surface.

Generally, a space of 1.5 m around each piece of playground equipment must be kept free of hard and sharp-edged as well as protruding parts.

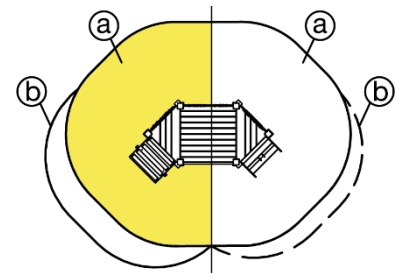

Key foundation list























































- ID = foundation number
- Type = OF=concrete foundation C20/25,
= FFk=eibe-prefab foundation small,
= FFr=eibe-prefab foundation round,
= FFg=eibe-prefab foundation large,
= FL3=Prepare AFTER the installation!
- X = horizontal measure to 0-point
- Y = vertical measure to 0-point
- Z = op edge of foundation to surface soil
- α = orientation of foundation
- FS = Size foundation: length x width x height (L x W x H)
- DS = Size drainage layer: length x width x height (L x W x H)
- SP = Slide attachment point (Slide Point)



Slides are not included.

Safe use of the equipment only with original eibe slide or by closing the slide opening in accordance with DIN EN 1176.

For detailed information, e.g. impact area or foundations, please see the enclosed slide installation instruction.

 Equipment data	 Safety standard	 Number of users
 Age group	 Minimum space	 Maximum height of fall
 Maintenance interval in months	 Maintenance	 Site plan
 Posts overview	 Foundation plan	 eibe prefab foundation
 Concrete foundation	 Foundation list	 Detail sheet / assembly example
 Impact zone plan	 Concrete foundation with concrete C20/25	 Scope of supply
 Not included in the delivery	 Wearing part (excluded from guarantee)	 Waiting period in days
 Assembly step	 View rotated by 90°	 View rotated by 180°
 Accessories kit	 Marking	 Dimensions in m
 Dimensions in cm	 Measuring	 Alignment
 Drilling (ø = drilling diameter)	 Drilling (t = drilling depth, ø = drilling diameter)	 Fix with hammer
 Tightening screws	 Close counterbores with closure plugs	 Cutting off
 Space	 Attention	 Dispose after assembly
 No passage	 No overlap	 Screw locking
 Correct	 Wrong	 Designed for supervised play areas
 Designed for indoor play areas	 May only be used under supervision!	 Checklist
 Largest part	 Heaviest part	 Number of foundations
 Foundation level	 Impact zone with requirements	 Impact zone without requirements
 Drainage	 Excavation	

Attentie

"Deze documenten dient u te bewaren!
Bij alle vragen of reclamaties graag de RM-code aangeven."

Montage instructie

Rondkop schroeven enkel vastkloppen met een rubberhamer ter vermindering van beschadiging van de corrosiebeschermingslaag. Graag bij alle moeren de bijbehorende ringen toepassen en beheersd vastdraaien. Wanneer er te ver ingedraaid wordt zal het hout beschadigen en stukjes hout brokkelen af. Voor verzonken schroeven en bouten zijn reeds verzonken gaten verdiept geboord. Gebruik een krachtige 2 trapsboormachine voor montage van het speeltoestel.

Locatie vereisten

Graag wijzen wij u op de documentatie van onze offertes en fundamentplannen. Voordat u het speeltoestel in gebruik stelt controleren of alle gereedschappen en bouwmaterialen zijn weggehaald. Afwijkende terrein condities zoals vochtige grond, vorst hebben invloed op de dimensionering van de fundering.

De montage-instructies in de onderhoudshandleiding moeten in acht worden genomen.

Meer informatie vindt u ook in de bijgevoegde onderhoudsinstructies!

Nadere specifieke informatie en onderhoudsvoorschriften die waar nodig in acht te nemen zijn bij de jaarlijkse hoofdinspectie, worden in dit document toegelicht.

Voetnoten:



Valdempende ondergrond volgens EN1176

a) Gele (binnen) ruimte geeft de ruimte aan met valdempingseisen.

Grondomstandigheden binnen de vrije valruimte (DE/AT/NL):							
✓	✓	✓	✓	✓	✓	✓	✓
zand	grind	houtsnippers	Rubber / syntetische valondergrond	gras	natuurlijke bodemplaat	beton	stehen
Grondomstandigheden binnen de vrije valruimte (andere landen):							
✓	✓	✓	✓	✓	✓	✓	✓
zand	grind	houtsnippers	Rubber / syntetische valondergrond	gras	natuurlijke bodemplaat	beton	stehen

b) De buitenste lijn geeft de volledige obstakelvrije ruimte aan .

In het algemeen moet rond elk speeltoestel een afstand van 1,5 m worden gemeten, vrij van harde, scherpe en uitstekende delen.

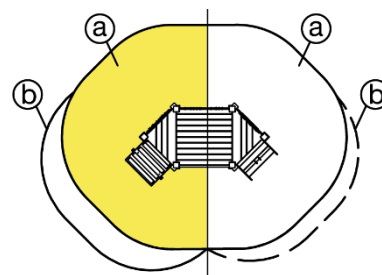

Legenda funderingslijst

























































- ID = funderingsnummer
- Type = OF=Stortbeton C20/25,
= FFK=eibe-prefabfundering klein,
= FFR=eibe-prefabfundering rond,
= FFg=eibe-prefabfundering groot,
= FL3=NA montage aan te brengen!
- X = horizontale maten naar 0-punt
- Y = verticale maten naar 0-punt
- Z = bovenzijde van de fundering tot grondniveau
- α = orientatie van de fundering
- FS = Grootte fundering: lengte x breedte x hoogte (L x B x H)
- DS = Grootte drainagelaag: lengte x breedte x hoogte (L x B x H)
- SP = Schuif bevestigingspunt (Slide Point)



Glijbanen zijn niet leveringsomvang opgenomen.

Veilig gebruik van het speeltoestel door toepassing van de originele eibe glijbaan en installatie met in achtneming van het juist sluiten van kieren van de glijbaan instap volgens DIN EN 1176.

Gedetailleerde opgave van bijvoorbeeld opvangzone, fundamentlocatie is in de apart bijgevoegde montagehandleiding van de glijbaan opgenomen.

 Toestelgegevens	 Norm	 Aantal gebruikers
 Leeftijds doelgroep	 Minimum ruimte	 Maximale valhoogte
 Onderhoudsfrequentie in maanden	 Onderhoud	 Overzichtsplan
 Palenoverzicht	 Funderingsplan	 eibe prefabfundering
 Stortbeton	 Fundamentenlijst	 Detail uitwerking / montagevoorbeeld
 Obstakelvrije ruimte	 Stortbeton volgens C20/25	 Leveringsomvang
 Niet in leveringsomvang opgenomen	 Slijtage onderdeel (uitgesloten van garantie)	 Wachtijd in dagen
 Montagestap	 Beeld gedraaid met 180°	 Beeld gedraaid met 180°
 Bijpak	 Markering	 Maten aangeduid in m
 Maten aangeduid in cm	 Meten	 Meten
 Boren (ø = boring diameter)	 Boren (D = diepte boring, ø = diameter boring)	 Boren (D = diepte boring, ø = diameter boring)
 Schroeven vastdraaien	 Afdoppen met bijgeleverde afdekoppen	 Afsnijden
 Afstand	 Let op	 Na montage verwerken
 Geen doorgang	 Geen overlap	 Schroefbevestiging
 Correct	 Fout	 Ontworpen voor speelplaatsen met toezicht
 Ontworpen voor indoor speelomgevingen	 Mag alleen onder toezicht worden gebruikt!	 checklist
 Grootste component	 Zwaarste component	 Aantal fundamente
 Fundering	 Opvangzone met vereisten	 Opvangzone zonder vereisten
 Afvoer	 Uitgraving	

Attention:

Conservez inconditionnellement les documents!

Communiquez pour toutes les demandes et les réclamations le RM-code, s'il vous plaît.

Indications du montage:

S'il vous plaît, ne tapez que doucement avec un marteau en gomme les vis à tête bombée, sous peine de anéantir la protection anticorrosion. S'il vous plaît, pour chaque écrou mettez une rondelle au-dessous et serrez tous les écrous avec soin. Dans le cas où les écrous sont trop tournés, ceux-ci éclatent surtout beaucoup de fibres en bois au-dessous de la tête de la vis de manière innécessaire. Toutes les fentes sont envisagées pour l'insertion des écrous de vis. La pose des écrous dans les fentes est facilitée, lorsqu'une ou deux écrous sont introduits dans la noix et ceux-ci sont posés sur le vis. Pour le montage de la structure une perceuse à deux marches approprié sera nécessaire

Exigences quant au profil du terrain:

S'il vous plaît, orientez vous aux informations dans nos dossiers d'appel d'offres et le plan des fondations. S'il vous plaît, assurez-vous avant la mise en service que tous les outils de montage soient éloignés. Lors de la constatation des conditions extraordinaires, telles que les sols tourbeux ou gelés, dans le lieu du montage, celles-ci doivent donc être prises en compte pour le dimensionnement des fondations.

Les instructions de montage figurant dans le manuel d'entretien doivent être respectées.

Vous trouverez également de plus amples informations dans les instructions d'entretien ci-jointes!

En plus, il y a, le cas échéant, dans les pages suivantes de cette documentation des contextes/situations, par exemple, des étapes des instructions de montage e de fiches techniques, qui doivent être aussi considérées dans l'inspection

Notes infrapaginales:**Surface d'impact selon EN1176**

a) La surface (interne) jaune montre la surface d'impact avec les exigences quant à l'absorption de chocs.

Nature du sol dans les limites de la surface d'impact: (DE/AT/NL):							
✓	✓	✓	✓	✓	✓	✓	✓
sable	gravier roulés	copeaux de bois	dalles de sécurité	gazon	couche superficielle du sol	béton	pierre
Nature du sol dans les limites de la surface d'impact: (d'autres pays):							
✓	✓	✓	✓	✓	✓	✓	✓
sable	gravier roulés	copeaux de bois	dalles de sécurité	gazon	couche superficielle du sol	béton	pierre

b) La ligne extérieure comprend toute la surface d'impact.

En général, une distance de 1,5 m doit être mesurée autour de chaque équipement de jeu, qui doit être exempt de parties dures et tranchantes ainsi que de parties saillantes.





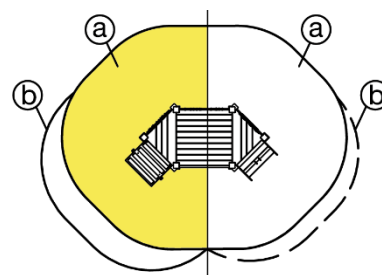



















































**Légende liste de fondations**

- ID = Numéro de fondation
 Type = OF=Fondation en béton à couler sur place C20/25,
 = FFk=fondation préfabriquée eibe petite,
 = FFr=fondation préfabriquée eibe ronde,
 = FFg=fondation préfabriquée eibe grande,
 = FL3=Créer APRÈS le montage!
 X = Mesure horizontale au point 0
 Y = Bord supérieur fondation pour le sol supérieur
 Z = Bord supérieur fondation pour le sol supérieur
 α = Rotation des fondations
 FS = Taille de la fondation: longueur x largeur x hauteur (L xlx H)
 DS = Taille de la couche de drainage: longueur x largeur x hauteur (L xlx H)
 SP = Faites glisser le point d'attache (Slide Point)

**Les toboggans ne sont pas inclus dans ce que la livraison comprend.**

L'utilisation n'est que secure avec un toboggan eibe ou avec la fermeture de l'ouverture selon l'EN 1176..

Pour des informations détaillées telles que la surface d'impact ou les fondations, veuillez-vous référer aux instructions d'installation du toboggan jointes séparément.

 Données de la structure	 Norme	 Quantité d'utilisateurs
 Classe d'âge	 Espace minimal	 Hauteur de chute livre maximale
 Intervalle de maintenance en mois	 Maintenance	 Plan d'ensemble
 Vue d'ensemble des poteaux	 Plan des fondations	 Fondation préfabriquée eibe
 Fondation en béton à couler sur place	 Liste des fondations	 Feuille de détail / Exemple de construction
 Plan de surface d'impact	 Fondation en béton à couler sur place avec sorte de béton C20/25	 Ce que la livraison comprend
 Non inclus dans ce que la livraison comprend	 Pièce consommable (non incluse dans la garantie)	 Temps d'attente en jours
 Phase de construction	 Vue tournée 90°	 Vue tournée 180°
 Accessoires	 Traçage	 Indiquer les dimensions en m
 Dimensions indiquées en cm.	 Mésurer	 Aligner
 Percer (\varnothing = Diamètre de perçage)	 Percer (t = Profondeur de perçage, \varnothing = Diamètre de perçage)	 Fixer avec un marteau
 Serrer les vis	 Fermer les trous fraisés avec des bouchons de fermeteure	 Couper
 Distance	 Attention	 Éliminer après le montage
 Aucune courbure	 Aucun chevauchement	 Dispositif de sécurité pour vis
 Correct	 False	 Conçu pour les aires surveillées
 Conçu pour les aires dans l'intérieur des édifices	 Ne peut être utilisé que sous surveillance!	 Aide-mémoire
 Élément le plus grand	 Élément le plus lourd	 Nombre des fondations
 Niveau de fondation	 Surface d'impact avec des exigences	 Surface d'impact sans exigences
 Drainage	 Excavation	

Atención:

¡Guarde siempre los documentos!

Indique en todas preguntas y reclamaciones el RM-code (vea la página del título de la instrucción del montaje).

Indicaciones del montaje:

Por favor, martillee los tornillos redondos planos sólo con un martillo de goma, porque en caso contrario la protección anticorrosión será destruida. Por favor, deposite un disco correspondiente debajo de cada muesca y atornille bien todas las muescas con cuidado. En caso de forzar demasiado la muesca, se desgarrarán innecesariamente muchas fibras de madera debajo de la cabeza del tornillo. Todos los rebajes están previstos para el hundimiento de las muescas de los tornillos. La superposición de las muescas en los rebajes será facilitada cuando se insertan una o dos muescas en el macho y con ello se superpone al tornillo. Para el montaje del equipo será necesaria una taladradora de dos marchas

Requisitos para el perfil del terreno:

Por favor, oriéntese a las informaciones en nuestra documentación de licitación y el plan de las cimentaciones. Por favor, asegúrese antes de la puesta en servicio de que todas las herramientas de montaje estén alejadas. Cuando se comprueben condiciones extraordinarias, tales como suelo de turba o suelo congelado, en el lugar de instalación, entonces deben considerarse estas condiciones en el dimensionamiento de las cimentaciones.

Deben observarse las instrucciones de montaje del manual de mantenimiento.

También se puede encontrar más información en las instrucciones de mantenimiento adjuntas!

Además, aparecen indicados en las siguientes páginas de esta documentación situaciones, tales como fases de las instrucciones de montaje y hojas detalladas, que del mismo modo deben ser tenidos en cuenta durante la inspección principal anual.

Notas a pie de página:



Superficie de impacto según EN1176

a) la superficie amarilla (interna) muestra la superficie de impacto con requisitos de absorción de choques.

Naturaleza del suelo dentro de la superficie de caída: (DE/AT/NL):							
✓	✓	✓	✓	✓	✓	✓	✓
arena	grava	viruta de madera	protección sintética contra caídas	césped	tierra	hormigón	piedra
Naturaleza del suelo dentro de la superficie de caída: (otros países):							
✓	✓	✓	✓	✓	✓	✓	✓
arena	grava	viruta de madera	protección sintética contra caídas	césped	tierra	hormigón	piedra

b) La línea exterior rodea toda la superficie de choque.

Generalmente se debe medir una distancia de 1,5 m. alrededor de cada equipo de juego, la cual está libre de partes con aristas duras y agudas, así como de partes salientes.





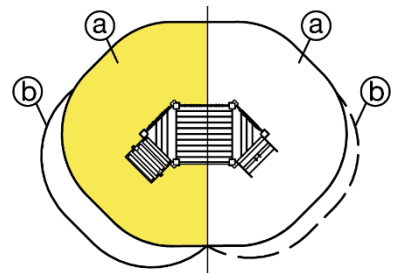



















































Legenda de la lista de cimentaciones

- ID = número de cimentación
- Type = OF=cimentación de cemento in situ C20/25,
= FFk=cimentación prefabricada eibe pequeña,
= FFr=cimentación prefabricada eibe redonda,
= FFg=cimentación prefabricada eibe grande,
= FL3=realizar TRAS el ontaje!
- X = medida horizontal hacia el punto 0
- Y = medida vertical hacia el punto 0
- Z = Borde superior de la cimentación hacia el suelo superior
- α = Giro de la cimentación
- FS = Tamaño de la cimentación: longitud x anchura x altura (L x W x H)
- DS = Tamaño de la capa de drenaje: longitud x anchura x altura (L x W x H)
- SP = Deslice el punto de fijación (Slide Point)



Los toboganes no están incluidos en el alcance del suministro.

El uso seguro solamente es posible con el tobogán de eibe o bien cerrando la apertura de acuerdo con la DIN EN 1176. Información detallada como superficie de impacto o cimentaciones, consulte las instrucciones de montaje de toboganes incluidas por separado.

 Datos del equipo	 Norma	 Número de usuarios
 Clasificación de edad	 Espacio mínimo	 Altura de caída libre máxima
 Intervalo de mantenimiento en meses	 Mantenimiento	 Plan general
 Visión general de los postes	 Plan de cimentación	 Cimentación prefabricada eibe
 Cimentación de hormigón in situ	 Lista de cimentación	 Hoja de detalle / Ejemplo de montaje
 Plano de la zona de impacto	 Cimentación de hormigón in situ con tipo de hormigón C20/25	 Alcance del suministro
 No incluido en el alcance del suministro	 Pieza de desgaste (no incluida en la garantía)	 Tiempo de espera en días
 Fase de construcción	 Vista rotada 90°	 Vista rotada 180°
 Accesorios	 Indicios	 Medida indicada en m
 Talla indicada en cm.	 Medir	 Alineación
 Taladrar (\varnothing = diámetro del taladro)	 Taladrar (t = profundidad del taladro, \varnothing = diámetro del taladro)	 Fijar con un martillo
 Apretar los tornillos	 Taladro avellanado con tapones de cierre	 Cortar
 Distancia	 Atención	 Eliminar tras el montaje
 Ningún combadura	 Ningún solapamiento	 Seguro de tornillos
 Correcto	 Falso	 Diseñado para las áreas vigiladas
 Diseñado para las áreas interiores	 ¡Sólo puede ser usado bajo supervisión!	 lista de comprobación
 Pieza más grande	 Pieza más pesada	 Número de fundamentos
 Nivel fundamento	 Superficie de impacto con requisitos	 Superficie de impacto sin requisitos
 Drenaje	 Excavación	



EN1176 - 1 / 6 / 7



0,00 x 0,00 x 0,00 m



-



0,00 m



2



3



- 1x ■
- 2x ●
- 3x ▲

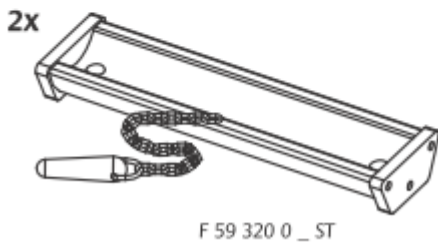
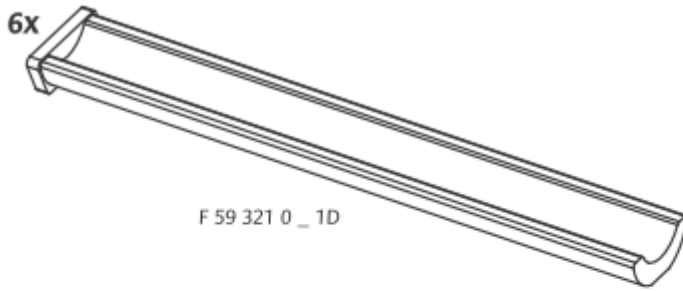

- 1. I I
- 2. H
- 3. H

AS 1

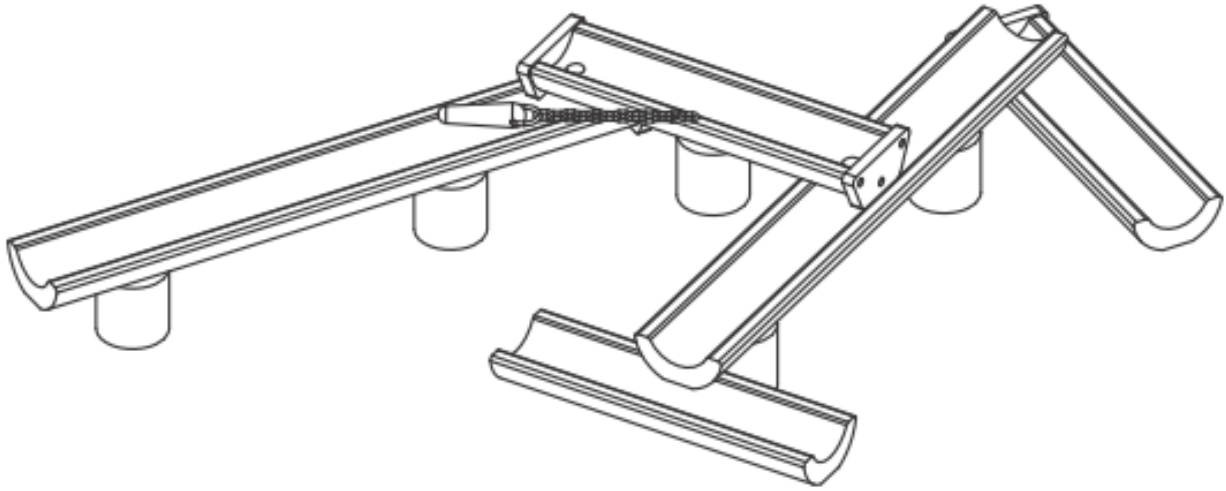



**eibe Produktion + Vertrieb
GmbH & Co. KG
Industriestraße 1
97285 Röttingen
Germany**

www.eibe.net